

Axles, Shafts & Pins Ejes y Pasadores Axes et Arbres	1839
Bellcranks & Spiders Manivelas y Satélites Renvois d'angle et croisillons	1834
Center Pin Kits Kits de Pasadores Centrales Joints et Kits de Réparation.	1846
King Pin Kits Kits de Pasadores del Vástago Joints et Kits de Réparation	1847
Knuckles Nudillos Jointures	1820
Links Varillas Bielles de Direction.	1829
Rod Ends Terminales de Dirección Embouts à Rotule	1852
Steer Axles Ejes de Dirección Essieu Direction.	1870
Steer Hubs Cubo de Rueda Moyeu Direction.	1836
Steering Columns Columnas de Dirección Colonne Direction	1862
Steering Cylinders Cilindros de Dirección Cylindres de direction	1871
Steering Hand Wheels Volantes Volants	1864
Steering Knobs Puños de Dirección Boutons de Direction.	1867
Torque Generators Generadores de Torque Générateurs de Couple.	1827



CA PROP 65 WARNING-Cancer/Reproductive Harm www.p65warnings.ca.gov

Steering Dirección

Knuckles Nudillos Jointures

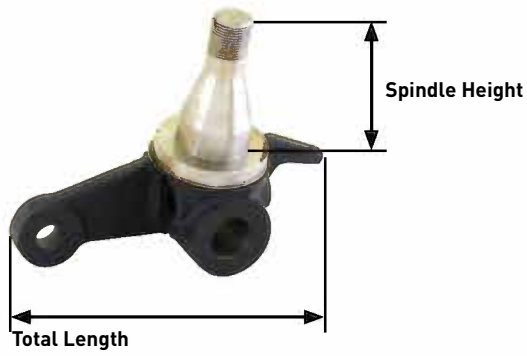

	Total Length ▼	Spindle Height	Right or Left handed
SY86923	3.15" 80mm	3.78" 96mm	Right hand



	Total Length ▼	Spindle Height	Right or Left handed
SY40694	3.37" 86mm	3.54" 90mm	Left hand



SY86927	3.15" 80mm	3.78" 96mm	Left hand
---------	---------------	---------------	-----------



SY86875	3.39" 86mm	3.54" 90mm	Left hand
---------	---------------	---------------	-----------



SY86921	3.27" 83mm	3.43" 87mm	Right hand
---------	---------------	---------------	------------



SY86904	3.39" 86mm	3.68" 93mm	Right hand
---------	---------------	---------------	------------



SY86925	3.27" 83mm	3.43" 87mm	Left hand
---------	---------------	---------------	-----------



SY86903	3.39" 86mm	3.69" 94mm	Right hand
---------	---------------	---------------	------------



SY86928	3.27" 83mm	3.43" 87mm	Left hand
---------	---------------	---------------	-----------



SY86906	3.39" 86mm	3.69" 94mm	Left hand
---------	---------------	---------------	-----------



CA PROP 65 WARNING: Cancer/Reproductive Harm www.p65warnings.ca.gov

Knuckles Nudillos Jointures

	Total Length ▼	Spindle Height	Right or Left handed		Total Length ▼	Spindle Height	Right or Left handed	
SY32643	3.47" 88mm	3.50" 89mm	Universal		SY86891	3.94" 100mm	3.62" 92mm	Left hand
SY1248320	3.74" 95mm	2.72" 69mm	Right hand		SY86911	3.96" 101mm	3.98" 101mm	Right hand
SY969784	3.86" 98mm	3.38" 86mm	Right hand		SY86913	3.98" 101mm	4.02" 102mm	Right hand
SY86897	3.93" 100mm	3.59" 91mm	Left hand		SY86907	3.98" 101mm	4.19" 106mm	Right hand
SY86898	3.93" 100mm	3.59" 91mm	Right hand		SY86908	3.98" 101mm	4.19" 106mm	Left hand
SY86894	3.94" 100mm	3.58" 91mm	Right hand		SY86905	4.02" 102mm	3.90" 99mm	Right hand
SY86890	3.94" 100mm	3.62" 92mm	Right hand		SY86916	4.06" 103mm	3.94" 100mm	Right hand

 CA PROP 65 WARNING: Cancer/Reproductive Harm www.p65warnings.ca.gov

Knuckles Nudillos Jointures

	Total Length ▼	Spindle Height	Right or Left handed
SY86918	4.06" 103mm	3.94" 100mm	Right hand
			
SY86919	4.06" 103mm	3.94" 100mm	Left hand
			
SY86920	4.06" 103mm	4.02" 102mm	Right hand
			
SY86900	4.25" 108mm	4.76" 121mm	Left hand
			
SY86932	4.27" 108mm	4.72" 120mm	Left hand
			
SY86933	4.27" 108mm	4.72" 120mm	Right hand
			
SY80177	4.33" 110mm	4.09" 104mm	Right hand
			

	Total Length ▼	Spindle Height	Right or Left handed
SY86878	4.37" 111mm	3.28" 83mm	Right hand
			
SY86879	4.37" 111mm	3.28" 83mm	Left hand
			
SY32004	4.49" 114mm	3.58" 91mm	Left hand
			
SY32010	4.49" 114mm	3.78" 96mm	Right hand
			
SY1248325	4.69" 119mm	3.46" 88mm	Universal
			
SY71768	5.00" 127mm	3.54" 90mm	Right hand
			
SY71770	5.00" 127mm	3.54" 90mm	Left hand
			

 CA PROP 65 WARNING: Cancer/Reproductive Harm www.p65warnings.ca.gov

Knuckles Nudillos Jointures

	Total Length ▼	Spindle Height	Right or Left handed		Total Length ▼	Spindle Height	Right or Left handed		
SY1248319	5.12" 130mm	3.15" 80mm	Left hand		SY86886	5.39" 137mm	4.29" 109mm	Right hand	
SY1244474	5.20" 132mm	2.95" 75mm	Left hand		SY1248317	5.51" 140mm	4.49" 114mm	Left hand	
SY86884	5.24" 133mm	3.47" 88mm	Left hand		SY1248318	5.51" 140mm	4.49" 114mm	Right hand	
SY86885	5.24" 133mm	3.47" 88mm	Right hand		SY86934	5.73" 146mm	4.33" 110mm	Right hand	
SY86931	5.26" 134mm	3.58" 91mm	Right hand		SY86867	5.87" 149mm	4.16" 106mm	Right hand	
SY1248333	5.28" 134mm	3.62" 92mm	Universal		SY86868	5.87" 149mm	4.16" 106mm	Left hand	
SY1248332	5.31" 135mm	2.60" 66mm	Left hand		SY1244475	6.10" 155mm	3.07" 78mm	Universal	

 CA PROP 65 WARNING: Cancer/Reproductive Harm www.p65warnings.ca.gov

Knuckles Nudillos Jointures

	Total Length ▼	Spindle Height	Right or Left handed
SY92352	6.18" 157mm	3.26" 83mm	Left hand
			
SY92353	6.18" 157mm	3.26" 83mm	Right hand
			
SY1244473	6.26" 159mm	3.43" 87mm	Left hand
			
SY86877	6.30" 160mm	4.02" 102mm	Left hand
			
SY92363	6.50" 165mm	3.19" 81mm	Left hand
			
SY92364	6.50" 165mm	3.19" 81mm	Right hand
			
SY86882	6.54" 166mm	3.31" 84mm	Right hand
			

	Total Length ▼	Spindle Height	Right or Left handed
SY86883	6.54" 166mm	3.31" 84mm	Left hand
			
SY86924	6.58" 167mm	3.39" 86mm	Right hand
			
SY87396	6.61" 168mm	3.87" 98mm	Universal
			
SY1248323	6.69" 170mm	4.17" 106mm	Left hand
			
SY1248324	6.69" 170mm	4.17" 106mm	Right hand
			
SY87397	6.73" 171mm	4.21" 107mm	Universal
			
SY40685	6.98" 177mm	3.91" 99mm	Universal
			

 CA PROP 65 WARNING: Cancer/Reproductive Harm www.p65warnings.ca.gov

Knuckles Nudillos Jointures

	Total Length ▼	Spindle Height	Right or Left handed		Total Length ▼	Spindle Height	Right or Left handed	
SY80712	7.02" 178mm	4.27" 108mm	Right hand		SY38876	7.55" 192mm	2.91" 74mm	Right hand
SY80713	7.02" 178mm	4.27" 108mm	Left hand		SY38875	7.56" 192mm	2.91" 74mm	Left hand
SY56979	7.05" 179mm	4.45" 113mm	Left hand		SY55354	7.92" 201mm	5.06" 129mm	Left hand
SY86887	7.15" 182mm	3.64" 92mm	Right hand		SY55356	7.92" 201mm	5.06" 129mm	Right hand
SY1222171	7.23" 184mm	4.37" 111mm	Left hand		SY86902	8.27" 210mm	4.29" 109mm	Left hand
SY86888	7.44" 189mm	4.32" 110mm	Left hand		SY108228	8.86" 225mm	5.24" 133mm	Right hand
SY86889	7.44" 189mm	4.32" 110mm	Right hand		SY1244468	8.86" 225mm	5.24" 133mm	Left hand

 CA PROP 65 WARNING: Cancer/Reproductive Harm www.p65warnings.ca.gov

Knuckles Nudillos Jointures

	Total Length ▼	Spindle Height	Right or Left handed		Total Length ▼	Spindle Height	Right or Left handed
SY1248315	8.89" 226mm	5.55" 141mm	Universal		SY1244162	9.41" 239mm	3.38" 86mm Left hand
SY45829	8.94" 227mm	4.13" 105mm	Right hand		SY86871	10.47" 266mm	6.65" 169mm Universal
SY45830	8.94" 227mm	4.13" 105mm	Left hand		SY31985	10.71" 272mm	4.49" 114mm Right hand
SY1244161	9.41" 239mm	3.38" 86mm	Right hand				

 CA PROP 65 WARNING: Cancer/Reproductive Harm www.p65warnings.ca.gov

Torque Generators Generadores de Torque Générateurs de Couple



	Total Length ▼	Type	Connections	Splines
SY93143	4.69" 119mm	Side connection	5	12



	Total Length ▼	Type	Connections	Splines
SY93144	5.20" 132mm	Side connection	5	12



SY71829	4.96" 126mm	Side connection	4	12
---------	----------------	-----------------	---	----



SY1232462	5.28" 134mm	Side connection	4	12
-----------	----------------	-----------------	---	----



SY86763	5.12" 130mm	Side connection	4	12
---------	----------------	-----------------	---	----



SY80939	5.31" 135mm	Bottom connection	4	12
---------	----------------	-------------------	---	----



SY93145	5.12" 130mm	Side connection	4	12
---------	----------------	-----------------	---	----



SY80998	5.35" 136mm	Bottom connection	4	9
---------	----------------	-------------------	---	---



SY93140	5.20" 132mm	Side connection	5	12
---------	----------------	-----------------	---	----



SY1240029	5.43" 138mm	Bottom connection	4	9
-----------	----------------	-------------------	---	---



CA PROP 65 WARNING: Cancer/Reproductive Harm www.p65warnings.ca.gov

Torque Generators Generadores de Torque Générateurs de Couple

	Total Length ▼	Type	Connections	Splines
SY33993	5.43" 138mm	Bottom connection	4	9
				
SY81148	5.59" 142mm	Bottom connection	4	9
				
SY80197	5.63" 143mm	Side connection	4	12
				
SY46838	5.79" 147mm	Side connection	4	12
				
SY86764	5.91" 150mm	Side connection	5	12
				
SY83138	6.54" 166mm	Bottom connection	4	9
				

	Total Length ▼	Type	Connections	Splines
SY86757	8.98" 228mm	Side connection	2	6
				
SY86765	9.13" 232mm	Moment amplifier	0	2
				
SY93090	9.13" 232mm	Moment amplifier	2	0
				
SY52781	9.17" 233mm	Moment amplifier	2	0
				
SY1248979	9.29" 236mm	Moment Amplifier	2	0
				
SY93141	9.33" 237mm	Moment amplifier	2	0
				

 CA PROP 65 WARNING: Cancer/Reproductive Harm www.p65warnings.ca.gov

Links Varillas Bielles de Direction



Tie Rod Links	Total Length ▼	Maximum Width	Grease Nipple
SY91035	4.69" 119mm	0.75" 19mm	None



SY86865	4.69" 119mm	0.87" 22mm	None
---------	----------------	---------------	------



SY91036	4.80" 122mm	0.75" 19mm	None
---------	----------------	---------------	------



SY1232127	4.84" 123mm	0.87" 22mm	None
-----------	----------------	---------------	------



SY86849	5.44" 138mm	0.55" 14mm	None
---------	----------------	---------------	------



SY86864	5.62" 143mm	0.35" 9mm	None
---------	----------------	--------------	------



SY76903	5.67" 144mm	0.31" 8mm	None
---------	----------------	--------------	------



Tie Rod Links	Total Length ▼	Maximum Width	Grease Nipple
SY76900	5.79" 147mm	0.31" 8mm	None



SY31648	5.83" 148mm	0.59" 15mm	Provided
---------	----------------	---------------	----------



SY86845	5.87" 149mm	0.47" 12mm	Provided
---------	----------------	---------------	----------



SY44109	5.94" 151mm	0.63" 16mm	Provided
---------	----------------	---------------	----------



SY41807	6.50" 165mm	0.63" 16mm	Provided
---------	----------------	---------------	----------



SY44110	6.65" 169mm	0.63" 16mm	Provided
---------	----------------	---------------	----------



SY86853	6.65" 169mm	0.63" 16mm	Provided
---------	----------------	---------------	----------



⚠ CA PROP 65 WARNING: Cancer/Reproductive Harm www.p65warnings.ca.gov

Links Varillas Bielles de Direction

Tie Rod Links	Total Length ▼	Maximum Width	Grease Nipple
SY83381	6.79" 172mm	0.59" 15mm	Provided
			
SY1239307	7.00" 178mm	0.63" 16mm	None
			
SY46971	7.13" 181mm	0.55" 14mm	Provided
			
SY86860	7.17" 182mm	0.71" 18mm	Provided
			
SY42001	7.83" 199mm	0.47" 12mm	Provided
			
SY43921	8.66" 220mm	0.47" 12mm	None
			

Tie Rod Links	Total Length ▼	Maximum Width	Grease Nipple
SY1239306	8.74" 222mm	0.39" 10mm	None
			
SY1239308	8.74" 222mm	0.39" 10mm	None
			
SY86861	8.74" 222mm	0.71" 18mm	Provided
			
SY35012	9.45" 240mm	0.59" 15mm	Provided
			
SY37131	9.45" 240mm	0.63" 16mm	Provided
			
SY58566	15.24" 387mm	0.79" 20mm	None
			

 CA PROP 65 WARNING: Cancer/Reproductive Harm www.p65warnings.ca.gov

Links Varillas Bielles de Direction

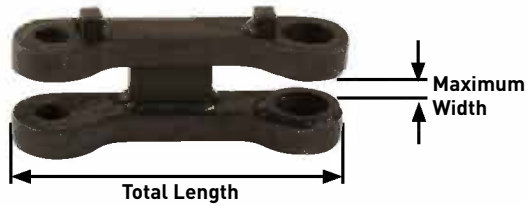

Tie Rod Bar Links	Total Length ▼	Maximum Width	Grease Nipple
SY91026	4.25" 108mm	1.69" 43mm	None
			
SY86863	4.29" 109mm	1.57" 40mm	Provided
			
SY91033	4.49" 114mm	1.57" 40mm	None
			
SY1232124	4.49" 114mm	1.57" 40mm	None
			
SY1232125	4.65" 118mm	2.24" 57mm	None
			
SY1232126	4.72" 120mm	1.65" 42mm	None
			
SY1232128	5.20" 132mm	2.20" 56mm	None

Tie Rod Bar Links	Total Length ▼	Maximum Width	Grease Nipple
SY1232129	5.20" 132mm	2.24" 57mm	None
			
SY34763	5.35" 136mm	1.93" 49mm	None
			
SY108292	5.39" 137mm	2.36" 60mm	None
			
SY38881	5.83" 148mm	2.48" 63mm	Provided
			
SY1232160	5.91" 150mm	2.36" 60mm	None
			
SY34755	6.18" 157mm	2.24" 57mm	None
			
SY86854	6.22" 158mm	2.24" 57mm	None

⚠ CA PROP 65 WARNING: Cancer/Reproductive Harm www.p65warnings.ca.gov

Links Varillas Bielles de Direction

Tie Rod Bar Links	Total Length ▼	Maximum Width	Grease Nipple
SY86855	6.22" 158mm	2.24" 57mm	None



SY91020	6.22" 158mm	2.36" 60mm	Provided
---------	----------------	---------------	----------



SY91021	6.22" 158mm	2.36" 60mm	Provided
---------	----------------	---------------	----------



SY34754	6.26" 159mm	2.24" 57mm	None
---------	----------------	---------------	------



SY1232151	6.89" 175mm	2.32" 59mm	Provided
-----------	----------------	---------------	----------

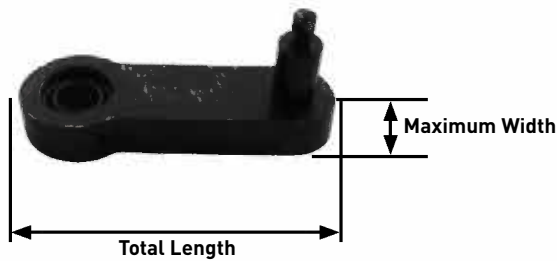

Link Assembly	Total Length ▼	Maximum Width	Grease Nipple
SY86851	5.47" 139mm	0.79" 20mm	Provided



Tie Rod Bar Links	Total Length ▼	Maximum Width	Grease Nipple
SY52575	7.28" 185mm	2.48" 63mm	Provided



SY1232152	7.76" 197mm	2.28" 58mm	None
-----------	----------------	---------------	------



SY31666	8.54" 217mm	2.36" 60mm	Provided
---------	----------------	---------------	----------



SY52608	8.62" 219mm	2.83" 72mm	Provided
---------	----------------	---------------	----------



Link Assembly	Total Length ▼	Maximum Width	Grease Nipple
SY86852	5.51" 140mm	0.75" 19mm	Provided



⚠ CA PROP 65 WARNING: Cancer/Reproductive Harm www.p65warnings.ca.gov

Links Varillas Bielles de Direction



Fork End Links	Total Length ▼	Maximum Width	Grease Nipple
SY86857	5.87" 149mm	1.65" 42mm	None



Fork End Links	Total Length ▼	Maximum Width	Grease Nipple
SY76901	6.50" 165mm	1.93" 49mm	None



SY86862	5.87" 149mm	1.65" 42mm	None
---------	----------------	---------------	------



SY86856	6.54" 166mm	1.93" 49mm	None
---------	----------------	---------------	------

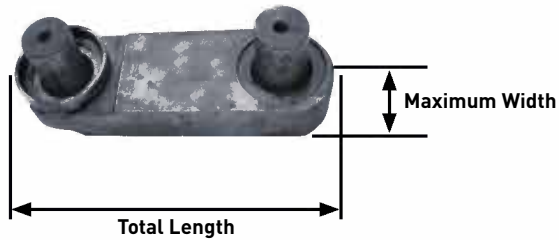

Special Link	Total Length ▼	Maximum Width	Grease Nipple
SY86848	8.07" 205mm	1.42" 36mm	None



Bellcranks & Spiders Manivelas y Satélites Renvois d'angle et croisillons

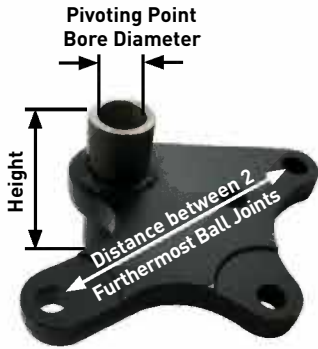

	Pivoting Point Bore Diameter ▼	Height	Distance between 2 Furthest Ball Joints
SY88576	1.26" 32mm	6.17" 157mm	8.54" 217mm



SY86956	1.38" 35mm	3.11" 79mm	10.31" 262mm
---------	------------	------------	--------------



SY86955	1.38" 35mm	5.21" 132mm	9.31" 236mm
---------	------------	-------------	-------------



SY86954	1.38" 35mm	5.25" 133mm	9.39" 239mm
---------	------------	-------------	-------------







SY124898	1.46" 37mm	5.54" 141mm	8.69" 221mm
----------	------------	-------------	-------------



 CA PROP 65 WARNING: Cancer/Reproductive Harm www.p65warnings.ca.gov

Bellcranks & Spiders Manivelas y Satélites Renvois d'angle et croisillons

	Pivoting Point Bore Diameter ▼		Height		Distance between 2 Furthestmost Ball Joints	
SY40651	1.50"	38mm	3.50"	89mm	9.22"	234mm
						
SY40688	1.99"	51mm	3.50"	89mm	9.65"	245mm
						
SY40693	2.00"	51mm	3.49"	89mm	9.33"	237mm
						
SY40658	3.15"	80mm	2.87"	73mm	10.72"	272mm
						
SY86953	4.33"	110mm	3.94"	100mm	14.50"	368mm
						

 CA PROP 65 WARNING: Cancer/Reproductive Harm www.p65warnings.ca.gov

Steer Hubs Cubo de Rueda Moyeu Direction



	Total Height ▼		Wheel Bolt Holes
SY1248355	3.31" 84mm		6



	Total Height ▼		Wheel Bolt Holes
SY108290	3.50" 89mm		6



SY71825	3.35" 85mm		6
---------	------------	--	---



SY86967	3.58" 91mm		6
---------	------------	--	---



SY1248334	3.35" 85mm		6
-----------	------------	--	---



SY86965	3.59" 91mm		6
---------	------------	--	---



SY1220105	3.46" 88mm		6
-----------	------------	--	---



SY40663	3.64" 92mm		6
---------	------------	--	---



SY40657	3.50" 89mm		5
---------	------------	--	---



SY86962	3.70" 94mm		6
---------	------------	--	---



CA PROP 65 WARNING: Cancer/Reproductive Harm www.p65warnings.ca.gov

Steer Hubs **Cubo de Rueda** Moyeu Direction

	Total Height ▼		Wheel Bolt Holes		Total Height ▼		Wheel Bolt Holes		
SY32637	3.72"	94mm	6		SY86970	4.06"	103mm	8	
SY1248337	3.74"	95mm	6		SY1248357	4.13"	105mm	6	
SY1248364	3.82"	97mm	5		SY45891	4.25"	108mm	5	
SY86969	3.90"	99mm	6		SY86968	4.45"	113mm	6	
SY1248354	3.94"	100mm	6		SY32100	4.53"	115mm	5	
SY1248353	3.98"	101mm	6		SY1248363	4.69"	119mm	5	

 CA PROP 65 WARNING: Cancer/Reproductive Harm www.p65warnings.ca.gov

Steer Hubs **Cubo de Rueda** Moyeu Direction

	Total Height ▼	Wheel Bolt Holes
SY33128	4.92" 125mm	6



	Total Height ▼	Wheel Bolt Holes
SY38988	6.50" 165mm	8



 CA PROP 65 WARNING: Cancer/Reproductive Harm www.p65warnings.ca.gov

Axles, Shafts & Pins Ejes y Pasadores Axes et Arbres

Axle without Body Machining



	Overall Width ▼		Diameter	
SY46240	1.12"	28mm	0.47"	12mm
SY52567	2.63"	67mm	1.06"	27mm
SY92327	3.50"	89mm	0.38"	10mm
SY41645	3.62"	92mm	1.38"	35mm
SY1248704	5.50"	140mm	2.50"	64mm
SY92384	5.74"	146mm	2.24"	57mm
SY40281	6.50"	165mm	1.00"	25mm

	Overall Width ▼		Diameter	
SY40608	6.71"	170mm	1.63"	41mm
SY88779	7.63"	194mm	1.25"	32mm
SY53196	7.71"	196mm	1.10"	28mm
SY33097	7.76"	197mm	0.50"	13mm
SY88784	9.88"	251mm	1.75"	44mm
SY92350	10.82"	275mm	1.50"	38mm
SY92357	17.25"	438mm	1.13"	29mm

Axle with 1 Drilled Hole



	Overall Width ▼		Diameter	
SY1244450	1.20"	30mm	0.47"	12mm
SY99-00949	1.38"	35mm	0.63"	16mm
SY99-00287	1.75"	44mm	0.75"	19mm
SY83123	2.25"	57mm	0.75"	19mm
SY99-04670	2.28"	58mm	0.50"	13mm
SY1244451	2.31"	58mm	0.75"	19mm
SY1244453	2.44"	62mm	0.75"	19mm
SY99-01632	2.77"	70mm	1.25"	32mm
SY31953	3.00"	76mm	0.68"	17mm
SY92354	3.00"	76mm	0.79"	20mm
SY40258	3.00"	76mm	1.25"	32mm
SY99-02346	3.24"	82mm	1.50"	38mm
SY92382	3.95"	100mm	0.75"	19mm
SY92318	4.00"	102mm	0.75"	19mm
SY99-03592	4.00"	102mm	0.98"	25mm
SY92395	4.01"	102mm	0.98"	25mm
SY88786	4.38"	111mm	0.68"	17mm
SY92340	4.41"	112mm	0.75"	19mm
SY99-01300	4.41"	112mm	0.75"	19mm
SY32869	4.42"	112mm	0.87"	22mm
SY52102	4.53"	115mm	0.75"	19mm
SY1248175	4.53"	115mm	1.19"	20mm
SY1220226	4.63"	118mm	0.98"	25mm
SY1248178	4.64"	118mm	1.25"	32mm
SY83070	4.65"	118mm	0.87"	22mm
SY40259	4.68"	119mm	0.75"	19mm
SY43775	4.75"	121mm	1.38"	35mm
SY1244452	5.00"	127mm	0.68"	17mm

	Overall Width ▼		Diameter	
SY39653	5.12"	130mm	0.75"	19mm
SY40567	5.50"	140mm	0.68"	17mm
SY40550	5.57"	141mm	1.08"	27mm
SY52387	5.70"	145mm	0.67"	17mm
SY48136	5.72"	145mm	0.98"	25mm
SY88787	5.86"	149mm	0.87"	22mm
SY99-04507	5.87"	149mm	0.67"	17mm
SY1234051	5.91"	150mm	0.75"	19mm
SY99-01260	5.91"	150mm	0.98"	25mm
SY1248981	5.91"	150mm	0.98"	25mm
SY1248703	5.92"	150mm	0.98"	25mm
SY108210	6.10"	155mm	1.10"	28mm
SY31956	6.13"	156mm	1.31"	33mm
SY40625	6.13"	156mm	1.38"	35mm
SY88809	6.19"	157mm	0.87"	22mm
SY88776	6.25"	159mm	0.87"	22mm
SY40266	6.25"	159mm	1.00"	25mm
SY40559	6.25"	159mm	1.13"	29mm
SY1248176	6.25"	159mm	1.19"	30mm
SY92309	6.26"	159mm	0.98"	25mm
SY41246	6.31"	160mm	1.19"	30mm
SY1248702	6.31"	160mm	1.19"	30mm
SY1244449	6.38"	162mm	0.79"	20mm
SY88785	6.38"	162mm	0.87"	22mm
SY32870	6.50"	165mm	0.87"	22mm
SY43712	6.50"	165mm	1.38"	35mm
SY52573	6.61"	168mm	0.94"	24mm
SY1244448	6.69"	170mm	0.79"	20mm

 CA PROP 65 WARNING: Cancer/Reproductive Harm www.p65warnings.ca.gov

Axles, Shafts & Pins Ejes y Pasadores Axes et Arbres

Axle with 1 Drilled Hole

	Overall Width ▼		Diameter	
SY1244461	6.71"	170mm	0.75"	19mm
SY1248174	6.75"	171mm	1.00"	25mm
SY40687	6.81"	173mm	1.45"	37mm
SY125586	6.96"	177mm	0.49"	12mm
SY88790	7.00"	178mm	1.11"	28mm
SY40075	7.17"	182mm	0.79"	20mm
SY88778	7.28"	185mm	1.11"	28mm
SY43938	7.28"	185mm	1.19"	30mm
SY92328	7.30"	185mm	0.98"	25mm
SY36108	7.31"	186mm	1.25"	32mm
SY40560	7.47"	190mm	1.50"	38mm
SY88797	7.50"	191mm	1.25"	32mm
SY88780	7.73"	196mm	1.19"	30mm
SY88796	7.75"	197mm	1.13"	29mm

	Overall Width ▼		Diameter	
SY53906	7.80"	198mm	1.25"	32mm
SY43693	7.84"	199mm	1.25"	32mm
SY88782	8.19"	208mm	1.11"	28mm
SY45584	8.50"	216mm	1.00"	25mm
SY88783	8.57"	218mm	1.57"	40mm
SY52110	8.66"	220mm	1.13"	29mm
SY99-00945	8.74"	222mm	0.75"	19mm
SY38012	8.75"	222mm	0.75"	19mm
SY48229	8.88"	226mm	1.19"	30mm
SY88807	9.50"	241mm	1.50"	38mm
SY48144	9.59"	244mm	1.89"	48mm
SY40614	9.81"	249mm	1.75"	44mm
SY23013	12.06"	306mm	0.44"	11mm

Axle with 2 Drilled Holes

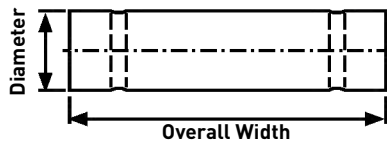

	Overall Width ▼		Diameter	
SY34092	2.17"	55mm	0.62"	16mm
SY1244456	2.80"	71mm	0.78"	20mm
SY29274	3.46"	88mm	0.50"	13mm
SY92365	4.25"	108mm	0.98"	25mm
SY99-04463	4.72"	120mm	0.78"	20mm
SY1244454	4.84"	123mm	0.98"	25mm
SY1244455	5.00"	127mm	0.78"	20mm
SY40299	5.03"	128mm	0.75"	19mm
SY1248183	5.12"	130mm	0.78"	20mm
SY36722	5.75"	146mm	1.00"	25mm
SY92383	6.31"	160mm	0.75"	19mm
SY43724	6.38"	162mm	1.38"	35mm
SY44199	6.38"	162mm	1.38"	35mm
SY92314	6.50"	165mm	0.38"	10mm
SY40277	6.58"	167mm	1.13"	29mm
SY40592	6.75"	171mm	1.25"	32mm
SY48143	6.94"	176mm	1.31"	33mm
SY48138	7.00"	178mm	1.19"	30mm
SY44197	7.25"	184mm	1.38"	35mm
SY88791	7.36"	187mm	1.11"	28mm
SY52664	7.38"	187mm	1.09"	28mm
SY88808	7.38"	187mm	1.88"	48mm
SY45084	7.39"	188mm	1.25"	32mm
SY88794	7.44"	189mm	1.11"	28mm
SY31957	7.50"	191mm	1.00"	25mm

	Overall Width ▼		Diameter	
SY88788	7.50"	191mm	1.06"	27mm
SY88793	7.50"	191mm	1.11"	28mm
SY88795	7.50"	191mm	1.13"	29mm
SY31950	7.61"	193mm	1.25"	32mm
SY48142	7.63"	194mm	1.31"	33mm
SY99-00714	7.68"	195mm	1.06"	27mm
SY44221	7.68"	195mm	1.18"	30mm
SY88781	7.75"	197mm	1.10"	28mm
SY88789	7.83"	199mm	1.10"	28mm
SY51817	7.91"	201mm	1.11"	28mm
SY51816	8.03"	204mm	1.11"	28mm
SY31949	8.31"	211mm	1.25"	32mm
SY48140	8.45"	215mm	1.19"	30mm
SY88802	8.46"	215mm	1.30"	33mm
SY43733	8.50"	216mm	1.38"	35mm
SY88800	8.75"	222mm	1.25"	32mm
SY31948	8.84"	225mm	1.25"	32mm
SY88801	8.86"	225mm	1.25"	32mm
SY88799	9.09"	231mm	1.25"	32mm
SY88811	9.13"	232mm	1.25"	32mm
SY54129	9.13"	232mm	1.38"	35mm
SY88806	9.21"	234mm	1.38"	35mm
SY108291	10.75"	273mm	1.56"	40mm
SY39096	16.94"	430mm	1.50"	38mm

 CA PROP 65 WARNING: Cancer/Reproductive Harm www.p65warnings.ca.gov

Axles, Shafts & Pins Ejes y Pasadores Axes et Arbres

Axle with Head and Drilled Hole or Grove

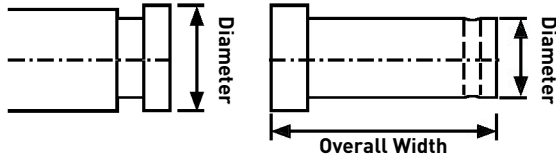

	Overall Width ▼		Diameter	
SY71814	1.77"	45mm	0.66"	17mm
SY1248180	1.81"	46mm	0.63"	16mm
SY1220238	2.44"	62mm	0.77"	20mm
SY46256	3.54"	90mm	1.12"	28mm
SY44969	3.68"	93mm	1.12"	28mm
SY108298	7.19"	183mm	1.63"	41mm

	Overall Width ▼		Diameter	
SY38063	7.50"	191mm	0.99"	25mm
SY108330	8.13"	207mm	2.13"	54mm
SY88804	9.19"	233mm	1.38"	35mm
SY45895	9.28"	236mm	1.19"	30mm
SY92310	12.38"	314mm	0.75"	19mm

Axle with Grove at the Lip

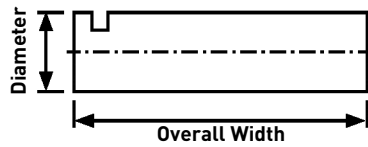

	Overall Width ▼		Diameter	
SY1244458	2.36"	60mm	0.63"	16mm
SY83104	3.17"	81mm	1.50"	38mm

	Overall Width ▼		Diameter	
SY40630	5.69"	145mm	1.13"	29mm
SY92355	7.60"	193mm	0.98"	25mm

Axle with 2 Grooves

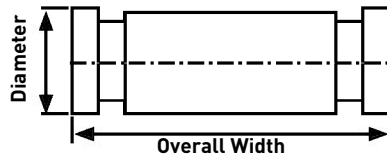



	Overall Width ▼		Diameter	
SY40746	1.15"	29mm	0.38"	10mm
SY46660	1.81"	46mm	0.63"	16mm
SY44873	2.66"	68mm	0.63"	16mm
SY92325	2.75"	70mm	2.78"	71mm

	Overall Width ▼		Diameter	
SY81064	5.88"	149mm	1.56"	40mm
SY54152	9.06"	230mm	1.38"	35mm
SY43902	16.25"	413mm	1.50"	38mm

Special

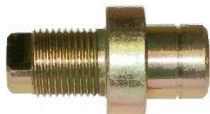









	Overall Length ▼		Shaft Length (from Under Head)		Diameter		Thread
SY92334	1.75"	44mm			0.22"	6mm	M7 x 1.00
SY92386	1.78"	45mm	0.55"	14mm	1.00"	25mm	5/8" - 18



 CA PROP 65 WARNING: Cancer/Reproductive Harm www.p65warnings.ca.gov









Axles, Shafts & Pins Ejes y Pasadores Axes et Arbres

Special

	Overall Length ▼		Shaft Length (from Under Head)		Diameter		Thread
SY92321	1.94"	49mm	1.14"	29mm	0.48"	12mm	M10 x 1.50
							
SY99-02615A	2.06"	52mm			0.75"	19mm	3/8" - 16
							
SY92341	2.17"	55mm	1.50"	38mm	0.50"	13mm	None
							
SY1248173	2.19"	56mm	2.06"	52mm	0.62"	16mm	M6 x 1.00
							
SY46670	2.88"	73mm			0.59"	15mm	None
							
SY92358	2.98"	76mm			1.18"	30mm	None
							
SY99-06239	3.00"	76mm			0.98"	25mm	None
							
SY92324	3.46"	88mm	3.20"	81mm	0.75"	19mm	None
							
SY52208	3.85"	98mm			0.25"	6mm	1/4" - 20
							
SY1248181	3.88"	99mm			0.78"	20mm	None
							
SY1248182	4.53"	115mm			0.78"	20mm	None
							

 CA PROP 65 WARNING: Cancer/Reproductive Harm www.p65warnings.ca.gov













Axles, Shafts & Pins Ejes y Pasadores Axes et Arbres

Special	Overall Length ▼		Shaft Length (from Under Head)		Diameter		Thread
SY77818	4.63"	118mm	4.28"	109mm	0.63"	16mm	5/8-11
							
SY1248184	4.72"	120mm			2.48"	63mm	1/8" - 28 BSP
							
SY1248177	5.81"	148mm			1.18"	30mm	M6 x 1.00
							
SY77114	5.64"	143mm	5.25"	133mm	0.88"	22mm	7/8-14 UNF
							
SY43758	6.50"	165mm			1.38"	35mm	None
							
SY92259	7.60"	193mm	7.43"	189mm	1.00"	25mm	None
							
SY81413	9.58"	243mm			1.75"	44mm	1 1/2" - 12 1 3/8" - 12
							
SY99-03258	9.72"	247mm			0.98"	25mm	3/8" - 16
							
SY92385	15.98"	406mm	15.50"	394mm	0.75"	19mm	3/4" - 10 UNC
							

 CA PROP 65 WARNING: Cancer/Reproductive Harm www.p65warnings.ca.gov













Axles, Shafts & Pins Ejes y Pasadores Axes et Arbres

Axle Greasable

	Overall Width ▼		Diameter		Thread
SY1244463	1.81"	46mm	0.63"	16mm	1/4" UNF
					
SY31290	2.25"	57mm	0.61"	15mm	1/8" BSP
					
SY46670	2.88"	73mm	0.59"	15mm	
					
SY43555	3.15"	80mm	0.56"	14mm	1/4" UNF
					
SY43554	3.16"	80mm	0.56"	14mm	1/4" UNF
					
SY1244462	3.54"	90mm	1.12"	28mm	1/4" UNF
					
SY1244460	3.54"	90mm	1.50"	38mm	1/8" BSP
					
SY45334	3.94"	100mm	0.87"	22mm	1/4" UNF
					
SY96471	4.00"	102mm	0.98"	25mm	1/4" UNF
					
SY1244465	4.02"	102mm	0.98"	25mm	1/8" BSP
					
SY43592	4.25"	108mm	0.98"	25mm	M6
					
SY36703	5.00"	127mm	0.98"	25mm	1/4" FLUSH
					
SY56217	5.55"	141mm	1.99"	51mm	1/8" BSP
					

 CA PROP 65 WARNING: Cancer/Reproductive Harm www.p65warnings.ca.gov

Axles, Shafts & Pins Ejes y Pasadores Axes et Arbres

Axle Greasable	Overall Width ▼		Diameter		Thread
SY99-00140	5.63"	143mm	1.18"	30mm	1/4" UNF
					
SY1244467	5.87"	149mm	0.67"	17mm	1/4" FLUSH
					
SY43758	6.50"	165mm	1.38"	35mm	
					
SY32871	6.50"	165mm	0.62"	16mm	1/4" UNF
					
SY99-00952	7.32"	186mm	0.98"	25mm	1/4" UNF
					
SY1244466	7.48"	190mm	0.98"	25mm	1/4" FLUSH
					
SY1244464	7.91"	201mm	0.98"	25mm	1/4" UNF
					
SY31931	7.97"	202mm	1.06"	27mm	1/8" BSP
					
SY45605	7.98"	203mm	0.98"	25mm	1/4" UNF
					
SY43509	8.00"	203mm	0.98"	25mm	1/4" UNF
					
SY1220006	8.31"	211mm	1.57"	40mm	1/8" BSP
					
SY99-03258	9.72"	247mm	0.98"	25mm	3/8" - 16
					

 CA PROP 65 WARNING: Cancer/Reproductive Harm www.p65warnings.ca.gov

Center Pin Kits Kits de Pasadores Centrales Joints et Kits de Réparation











	Pin#	Length ▼	Diameter	# of Grooves	# of Grease Holes
	SY40630	5.69" 145mm	1.13" 29mm	1	
	SY40592	6.75" 171mm	1.25" 32mm	1	
	SY40687	6.81" 173mm	1.47" 37mm	1	
	SY31947	7.13" 181mm	1.25" 32mm	1	8
	SY31945	7.13" 181mm	1.25" 32mm	2	8
	SY45084	7.39" 188mm	1.25" 32mm		8
	SY43625	7.84" 199mm	1.25" 32mm	2	
	SY31949	8.31" 211mm	1.25" 32mm		8

CA PROP 65 WARNING: Cancer/Reproductive Harm www.p65warnings.ca.gov









King Pin Kits Kits de Pasadores del Vástago Joints et Kits de Réparation



	Pin#	Length ▼	Diameter	# of Grooves	# of Grease Holes
	SY46660	1.82" 46mm	0.63" 16mm	2	
	SY23013	2.63" 67mm	0.44" 11mm		
	SY40259	4.88" 124mm	0.75" 19mm	1	
	SY40299	5.03" 128mm	0.75" 19mm	2	2
	SY40567	5.50" 140mm	0.88" 22mm	1	
	SY48136	5.72" 145mm	0.98" 25mm	3	3
	SY88787	5.86" 149mm	0.86" 22mm	1	
	SY31956	6.13" 156mm	1.31" 33mm	1	

 CA PROP 65 WARNING: Cancer/Reproductive Harm www.p65warnings.ca.gov

King Pin Kits Kits de Pasadores del Vástago Joints et Kits de Réparation

	Pin#	Length ▼	Diameter	# of Grooves	# of Grease Holes
	SY31956	6.13" 156mm	1.31" 33mm	1	
	SY40625	6.13" 156mm	1.38" 35mm		
	SY45895	6.13" 156mm	1.38" 35mm	1	
	SY40266	6.25" 159mm	1.00" 25mm	1	
	SY40559	6.25" 159mm	1.13" 29mm	1	
	SY41246	6.31" 160mm	1.19" 30mm	1	
	SY41246	6.31" 160mm	1.19" 30mm	1	
	SY40281	6.50" 165mm	1.00" 25mm	1	2
	SY40277	6.58" 167mm	1.13" 29mm	1	2

 CA PROP 65 WARNING: Cancer/Reproductive Harm www.p65warnings.ca.gov

King Pin Kits Kits de Pasadores del Vástago Joints et Kits de Réparation

	Pin#	Length ▼	Diameter	# of Grooves	# of Grease Holes
SY86732	SY48143	7.00" 178mm	1.00" 25mm	1	3
					
SY86727	SY88790	7.00" 178mm	1.11" 28mm		
					
SY48139	SY48138	7.00" 178mm	1.19" 30mm	3	3
					
SY541306	SY43823	7.06" 179mm	1.00" 25mm	3	1
					
SY541202	SY31947	7.13" 181mm	1.25" 32mm	1	8
					
SY541209	SY31945	7.13" 181mm	1.25" 32mm	2	8
					
SY541303	SY44197	7.25" 184mm	1.38" 35mm	2	4
					
SY541312	SY43938	7.28" 185mm	1.19" 30mm		
					
SY541109	SY40560	7.47" 190mm	1.50" 38mm	1	
					





 CA PROP 65 WARNING: Cancer/Reproductive Harm www.p65warnings.ca.gov

King Pin Kits Kits de Pasadores del Vástago Joints et Kits de Réparation

	Pin#	Length ▼	Diameter	# of Grooves	# of Grease Holes
	SY31950	7.61" 193mm	1.25" 32mm	2	4
	SY48142	7.63" 194mm	1.31" 33mm	1	3
	SY937516	7.69" 195mm	1.19" 30mm	1	4
	SY45084	7.78" 198mm	1.25" 32mm		8
	SY53906	7.80" 198mm	1.25" 32mm		
	SY43693	7.84" 199mm	1.25" 32mm	4	
	SY48140	8.45" 215mm	1.19" 30mm	1	3
	SY52110	8.63" 219mm	1.13" 29mm	1	
	SY31948	8.84" 225mm	1.25" 32mm		5

 CA PROP 65 WARNING: Cancer/Reproductive Harm www.p65warnings.ca.gov

King Pin Kits Kits de Pasadores del Vástago Joints et Kits de Réparation

	Pin#	Length ▼	Diameter	# of Grooves	# of Grease Holes
SY541213	SY541213	8.84" 225mm	1.25" 32mm		5
					
SY541207	SY31949	8.94" 227mm	1.25" 32mm		8
					
SY86754	SY88806	9.21" 234mm	1.38" 35mm	2	8
					
SY86712	SY88804	9.28" 236mm	1.38" 35mm		
					
SY48145	SY48144	9.59" 244mm	1.19" 30mm	1	4
					

 CA PROP 65 WARNING: Cancer/Reproductive Harm www.p65warnings.ca.gov

Rod Ends Terminales de Dirección Embouts à Rotule

Ball Joint Outer Thread

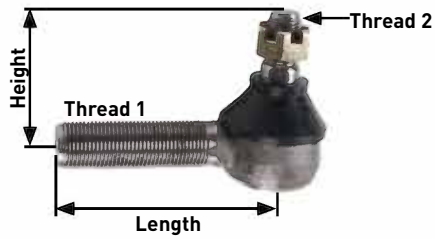

	Length ▼	Height	Thread Type 1	Thread Type 2	Grease Nipple
SY1232248	3.03" 77mm	1.97" 50mm	9/16"	7/16"	Yes



	Length ▼	Height	Thread Type 1	Thread Type 2	Grease Nipple
SY86792	3.15" 80mm	2.40" 61mm	M16	M14	No



SY1232247	3.03" 77mm	2.01" 51mm	9/16"	7/16"	Yes
-----------	---------------	---------------	-------	-------	-----



SY47512	3.27" 83mm	2.52" 64mm	1 1/16"	7/16"	Yes
---------	---------------	---------------	---------	-------	-----



SY42359	3.03" 77mm	2.05" 52mm	1 1/16"	1/2"	Yes
---------	---------------	---------------	---------	------	-----



SY86797	3.31" 84mm	2.95" 75mm	M22	M18	No
---------	---------------	---------------	-----	-----	----



SY86820	3.05" 77mm	2.28" 58mm	M22	M16	Yes
---------	---------------	---------------	-----	-----	-----



SY1232463	3.31" 84mm	2.95" 75mm	M22	M18	No
-----------	---------------	---------------	-----	-----	----



SY40611	3.15" 80mm	1.77" 45mm	1 1/16"	1/2"	Yes
---------	---------------	---------------	---------	------	-----



SY86813	3.35" 85mm	2.76" 70mm	M22	M18	No
---------	---------------	---------------	-----	-----	----



SY86838	3.15" 80mm	2.17" 55mm	M22	M18	No
---------	---------------	---------------	-----	-----	----



















SY86812	3.35" 85mm	2.87" 73mm	M22	M18	No
---------	---------------	---------------	-----	-----	----



CA PROP 65 WARNING: Cancer/Reproductive Harm www.p65warnings.ca.gov

Rod Ends Terminales de Dirección Embouts à Rotule

	Length ▼	Height	Thread Type 1	Thread Type 2	Grease Nipple		Length ▼	Height	Thread Type 1	Thread Type 2	Grease Nipple		
SY86831	3.35" 85mm	3.03" 77mm	M24	M20	No		SY86830	3.54" 90mm	2.95" 75mm	M24	M20	No	
SY53197	3.46" 88mm	2.28" 58mm	M22	M16	No		SY31962	3.54" 90mm	3.15" 80mm	M20	M16	Yes	
SY82350	3.46" 88mm	2.28" 58mm	M22	M16	No		SY31963	3.54" 90mm	3.15" 80mm	M20	M16	Yes	
SY40381	3.46" 88mm	2.52" 64mm	3/4"	9/16"	Yes		SY47511	3.60" 91mm	3.08" 78mm	1 1/16"	9/16"	Yes	
SY86809	3.54" 90mm	1.97" 50mm	M20	M14	Yes		SY86810	3.74" 95mm	1.97" 50mm	M22	M16	Yes	
SY86807	3.54" 90mm	2.36" 60mm	M20	M14	Yes		SY51843	3.74" 95mm	2.17" 55mm	M22	M20	Yes	
SY47542	3.54" 90mm	2.38" 60mm	M20	M16	Yes		SY45383	3.74" 95mm	2.36" 60mm	7/8"	5/8"	Yes	
SY52092	3.54" 90mm	2.76" 70mm	1"	5/8"	Yes		SY31486	3.74" 95mm	2.36" 60mm	M20	M16	Yes	

 CA PROP 65 WARNING: Cancer/Reproductive Harm www.p65warnings.ca.gov







Rod Ends Terminales de Dirección Embouts à Rotule

	Length ▼	Height	Thread Type 1	Thread Type 2	Grease Nipple
SY1248982	3.74" 95mm	2.36" 60mm	M22	M16	Yes
					
SY53198	3.74" 95mm	2.36" 60mm	M22	M20	No
					
SY52091	3.74" 95mm	2.56" 65mm	1"	5/8"	Yes
					
SY45382	3.74" 95mm	2.76" 70mm	7/8"	5/8"	Yes
					
SY86795	3.74" 95mm	2.76" 70mm	M20	M18	No
					
SY40554	3.74" 95mm	2.95" 75mm	1"	5/8"	Yes
					
SY86808	3.78" 96mm	2.28" 58mm	M20	M16	No
					
SY86835	3.82" 97mm	2.17" 55mm	M30	M16	Yes
					

	Length ▼	Height	Thread Type 1	Thread Type 2	Grease Nipple
SY40556	3.86" 98mm	2.68" 68mm	7/8"	5/8"	Yes
					
SY40557	3.86" 98mm	2.68" 68mm	7/8"	5/8"	Yes
					
SY86791	3.86" 98mm	2.95" 75mm	1"	3/4"	Yes
					
SY39862	3.86" 98mm	3.15" 80mm	1"	3/4"	Yes
					
SY86836	3.94" 100mm	2.24" 57mm	M30	M16	No
					
SY86840	3.94" 100mm	2.56" 65mm	M20	M16	No
					
SY86837	3.94" 100mm	2.60" 66mm	M20	M16	Yes
					
SY42330	3.98" 101mm	2.52" 64mm	M24	M20	No
					

 CA PROP 65 WARNING: Cancer/Reproductive Harm www.p65warnings.ca.gov

Rod Ends Terminales de Dirección Embouts à Rotule

	Length ▼	Height	Thread Type 1	Thread Type 2	Grease Nipple		Length ▼	Height	Thread Type 1	Thread Type 2	Grease Nipple	
SY86790	3.98" 101mm	2.52" 64mm	M24	M20	Yes		SY44647	4.73" 120mm	3.15" 80mm	1 1/8"	7/8"	Yes
SY40386	3.98" 101mm	2.99" 76mm	1"	5/8"	Yes		SY40569	4.96" 126mm	3.58" 91mm	1 1/8"	7/8"	Yes
SY1232123	4.02" 102mm	2.36" 60mm	M22	M16	No		SY48223	5.12" 130mm	2.56" 65mm	M25	M20	Yes
SY86811	4.13" 105mm	2.36" 60mm	M18	M12	Yes		SY86839	5.12" 130mm	3.03" 77mm	M18	M22	No
SY40570	4.72" 120mm	3.54" 90mm	1 1/8"	7/8"	Yes		SY86787	5.31" 135mm	3.15" 80mm	1 1/8"	7/8"	Yes
SY44646	4.73" 120mm	3.15" 80mm	1 1/8"	7/8"	Yes							

 CA PROP 65 WARNING: Cancer/Reproductive Harm www.p65warnings.ca.gov

Rod Ends Terminales de Dirección Embouts à Rotule

Ball Joint Inner Thread 1 Bolt

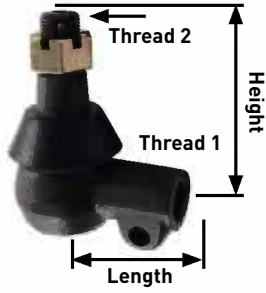

	Length ▼	Height	Thread Type 1	Thread Type 2	Grease Nipple
SY42284	2.56" 65mm	2.76" 70mm	1 ⁵ / ₁₆ "	5/8"	No



	Length ▼	Height	Thread Type 1	Thread Type 2	Grease Nipple
SY77665	3.35" 85mm	2.17" 55mm	1/2"	7/16"	Yes



SY86767	2.56" 65mm	3.54" 90mm	7/8"	7/8"	Yes
---------	---------------	---------------	------	------	-----



SY41822	4.41" 112mm	2.95" 75mm	1"	5/8"	Yes
---------	----------------	---------------	----	------	-----



Tie Rod with Fork End

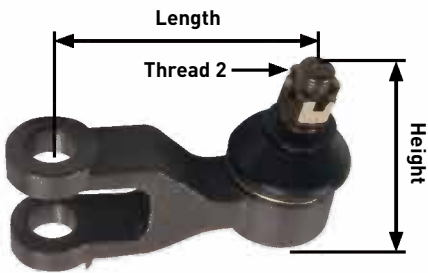

	Length ▼	Height	Thread Type 1	Thread Type 2	Grease Nipple
SY82766	3.03" 77mm	2.76" 70mm		M12	No



	Length ▼	Height	Thread Type 1	Thread Type 2	Grease Nipple
SY82765	3.39" 86mm	2.36" 60mm		M16	No



CA PROP 65 WARNING: Cancer/Reproductive Harm www.p65warnings.ca.gov

Rod Ends Terminales de Dirección Embouts à Rotule

Tie Rod + Cylindric Hole

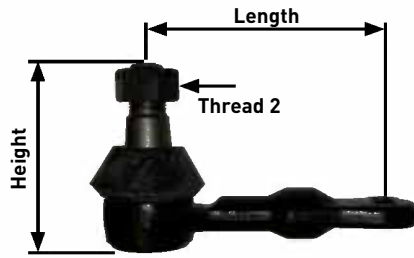

	Length ▼	Height	Thread Type 1	Thread Type 2	Grease Nipple
SY1220096	3.94" 100mm	2.95" 75mm		M16	Yes



	Length ▼	Height	Thread Type 1	Thread Type 2	Grease Nipple
SY73315	5.39" 137mm	2.28" 58mm		7/8"	Yes



SY86841	3.94" 100mm	3.07" 78mm		M16	Yes
---------	----------------	---------------	--	-----	-----



SY1232377	5.39" 137mm	2.28" 58mm		22/25"	Yes
-----------	----------------	---------------	--	--------	-----



SY51827	4.02" 102mm	3.07" 78mm		M16	Yes
---------	----------------	---------------	--	-----	-----



SY1232378	5.39" 137mm	2.28" 58mm		22/25"	Yes
-----------	----------------	---------------	--	--------	-----



SY1220196	4.06" 103mm	2.95" 75mm		M16	Yes
-----------	----------------	---------------	--	-----	-----



SY31712	5.51" 140mm	3.74" 95mm		3/4"	No
---------	----------------	---------------	--	------	----



SY52648	4.53" 115mm	3.54" 90mm		M20	Yes
---------	----------------	---------------	--	-----	-----



SY31222	7.48" 190mm	4.72" 120mm		7/8"	No
---------	----------------	----------------	--	------	----



⚠ CA PROP 65 WARNING: Cancer/Reproductive Harm www.p65warnings.ca.gov

Rod Ends Terminales de Dirección Embouts à Rotule

Tie Rod End with Negative Conical Hole

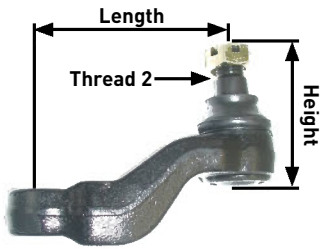

	Length ▼	Height	Thread Type 1	Thread Type 2	Grease Nipple
SY51831	3.94"	2.36"		M16	No
Left	100mm	60mm			



	Length ▼	Height	Thread Type 1	Thread Type 2	Grease Nipple
SY51826	3.94"	2.95"		M16	No
Right	100mm	75mm			



Tie Rod End with Positive Conical Hole

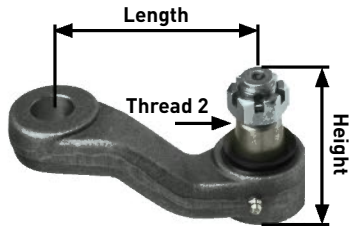

	Length ▼	Height	Thread Type 1	Thread Type 2	Grease Nipple
SY42329	4.41"	2.68"		M20	Yes
Right	112mm	68mm			



	Length ▼	Height	Thread Type 1	Thread Type 2	Grease Nipple
SY42331	4.41"	2.68"		M20	No
Left	112mm	68mm			



 CA PROP 65 WARNING: Cancer/Reproductive Harm www.p65warnings.ca.gov

Rod Ends Terminales de Dirección Embouts à Rotule

Tie Rod End with Axial End

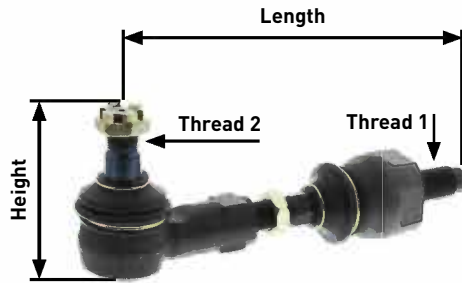

	Length ▼	Height	Thread Type 1	Thread Type 2	Grease Nipple
SY42060	8.86" 225mm	3.78" 96mm	M18	M20	No



	Length ▼	Height	Thread Type 1	Thread Type 2	Grease Nipple
SY1239316	22.04" 560mm	6.10" 155mm	M28	M30	No



	Length ▼	Height	Thread Type 1	Thread Type 2	Grease Nipple
SY1239314	22.44" 570mm	4.72" 120mm	M24	M24	No



	Length ▼	Height	Thread Type 1	Thread Type 2	Grease Nipple
SY1239315	22.44" 570mm	5.16" 131mm	M28	M30	No



Rod Ends Terminales de Dirección Embouts à Rotule

Male Spherical Rod End

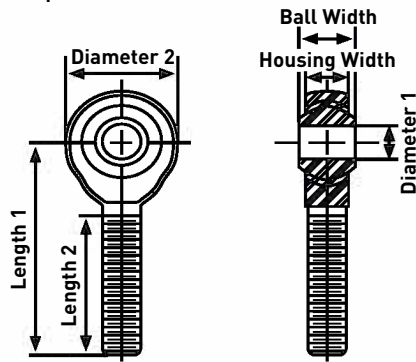



	Length 1 ▼	Length 2	Diameter 1	Diameter 2	Ball Width	Housing Width	Thread Style	Thread Size	Grease Nipple
	SY1239323 1.56" 40mm	1.00" 25mm	0.25" 6mm	0.75" 19mm	0.38" 10mm	0.28" 7mm	Left hand	1/4-28	None
	SY1239324 1.94" 49mm	1.25" 32mm	0.38" 10mm	1.00" 25mm	0.50" 13mm	0.41" 10mm	Right hand	3/8-24	None
	SY1232275 2.44" 62mm	1.50" 38mm	0.50" 13mm	1.31" 33mm	0.63" 16mm	0.50" 13mm	Right hand	1/2-20	None
	SY1232251 2.56" 65mm	1.77" 45mm	0.63" 16mm	1.75" 44mm	0.75" 19mm	0.28" 7mm	Right hand	3/4-06	Provided
	SY1232119 2.63" 67mm	1.63" 41mm	0.63" 16mm	1.50" 38mm	0.75" 19mm	0.56" 14mm	Right hand	5/16-18	None
	SY1239320 3.67" 93mm		0.37" 9mm	1.28" 33mm	0.44" 11mm		None		None
	SY1239319 3.72" 94mm		0.50" 13mm	1.33" 34mm	0.53" 13mm		None		None
	SY1232156 4.13" 105mm	2.13" 54mm	1.00" 25mm	2.75" 70mm	1.38" 35mm	1.00" 25mm	Right hand	1-12	Provided
	SY1232159 4.13" 105mm	2.13" 54mm	1.00" 25mm	2.75" 70mm	1.38" 35mm	1.00" 25mm	Left hand	1-12	Provided

 CA PROP 65 WARNING: Cancer/Reproductive Harm www.p65warnings.ca.gov

Rod Ends Terminales de Dirección Embouts à Rotule

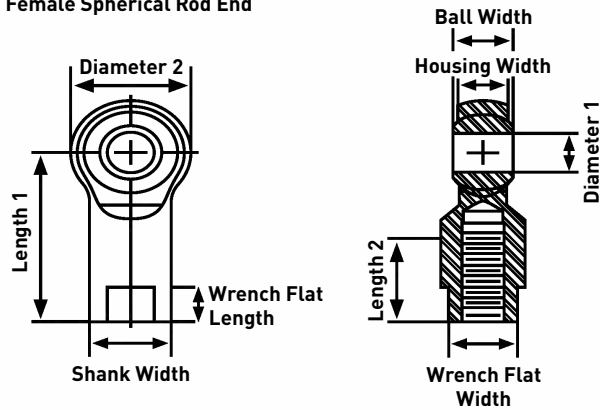
Female Spherical Rod End



	Length 1 ▼	Length 2	Diameter 1	Diameter 2	Ball Width	Housing Width	Shank Diameter	Wrench Flat Width	Wrench Flat Length	Thread Style	Thread Size	Grease Nipple
SY1232168	1.63" 41mm	0.94" 24mm	0.38" 10mm	1.00" 25mm	0.50" 13mm	0.41" 10mm	0.69" 18mm	0.56" 14mm	0.56" 14mm	Right hand	3/8-24	None
												
SY42198	1.63" 41mm	0.94" 24mm	0.51" 13mm	1.00" 25mm	0.50" 13mm	0.41" 10mm	0.69" 18mm	0.56" 14mm		Right hand	3/8-24	None
												
SY1232155	2.50" 64mm	1.38" 35mm	0.63" 16mm	1.50" 38mm	0.75" 19mm	0.48" 12mm	1.00" 25mm	0.88" 22mm		Right hand	5/16-18	Provided
												
SY1239325	2.50" 64mm	1.41" 36mm	0.63" 16mm	1.50" 38mm	0.75" 19mm	0.56" 14mm	1.00" 25mm	0.88" 22mm	0.50" 13mm	Left hand	5/16-18	Provided
												
SY1232250	2.50" 64mm	1.50" 38mm	0.63" 16mm	1.50" 38mm	0.75" 19mm	0.56" 14mm	1.00" 25mm	0.88" 22mm	0.50" 13mm	Right hand	5/16-18	None
												

 CA PROP 65 WARNING: Cancer/Reproductive Harm www.p65warnings.ca.gov











Steering Columns Columnas de Dirección Colonne Direction

	Used For ▼
SY40361	Allis Chalmers
	
SY1232268	Clark
	
SY1232269	Clark
	
SY1232270	Clark
	
SY1239177	Clark
	
SY1239181	Clark
	

	Used For ▼
SY1239185	Clark
	
SY1232271	Drexel
	
SY1239187	Genie
	
SY1239186	Gradall
	
SY1239179	Hyster
	
SY36653	Hyster, Raymond
	

⚠ CA PROP 65 WARNING: Cancer/Reproductive Harm www.p65warnings.ca.gov

Steering Columns Columnas de Dirección Colonne Direction

	Used For ▼		Used For ▼		
SY1239180	JLG, Skytrak, Gradall		SY1239182	Nissan	
SY1232272	Mitsubishi		SY1232274	Taylor Dunn	
SY1239184	Mitsubishi		SY1232273	Teledyne	
SY1239183	Moffett		SY39570	Yale	
SY1232237	Nissan		SY33992	Yale	

 CA PROP 65 WARNING: Cancer/Reproductive Harm www.p65warnings.ca.gov

Steering Hand Wheels Columnas de Dirección Colonne Direction

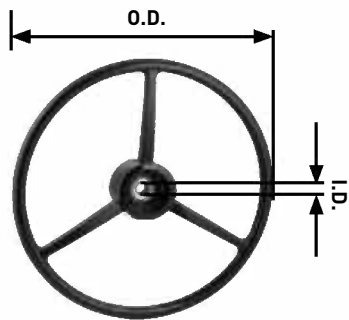

	O.D. ▼	I.D.	Used for
SY1232142	4.37" 111mm		Prime Mover



	O.D. ▼	I.D.	Used for
SY1232130	11.02" 280mm	1.69" 43mm	Baker, Linde



SY1232131	7.48" 190mm		Baker, Linde
-----------	----------------	--	--------------



SY1232146	11.69" 297mm	0.75" 19mm	Toyota
-----------	-----------------	---------------	--------



SY1232132	7.48" 190mm	0.79" 20mm	Baker, Linde
-----------	----------------	---------------	--------------



SY1222661	11.81" 300mm	0.75" 19mm	Toyota
-----------	-----------------	---------------	--------



SY1239303	9.84" 250mm	0.94" 24mm	Moffett, Teledyne
-----------	----------------	---------------	----------------------



SY1236712	11.81" 300mm	1.81" 46mm	Hyster, Yale
-----------	-----------------	---------------	--------------



SY1239305	9.84" 250mm	1.00" 25mm	Moffett
-----------	----------------	---------------	---------



SY1236710	11.81" 300mm	1.85" 47mm	Hyster, Yale
-----------	-----------------	---------------	--------------



⚠ CA PROP 65 WARNING: Cancer/Reproductive Harm www.p65warnings.ca.gov

Steering Hand Wheels Columnas de Dirección Colonne Direction

	O.D. ▼	I.D.	Used for		O.D. ▼	I.D.	Used for
SY1232145	11.81" 300mm	1.26" 32mm	TCM		SY1232138	13.78" 350mm	1.99" 51mm Hyundai
SY1232149	12.40" 315mm	1.97" 50mm	Moffett		SY1232137	13.78" 350mm	2.01" 51mm Hyundai
SY1239301	12.52" 318mm	0.66" 17mm	Caterpillar, Mitsubishi		SY1232135	13.78" 350mm	2.52" 64mm Daewoo
SY1232133	13.00" 330mm	2.32" 59mm	Clark		SY1236713	13.78" 350mm	2.68" 68mm Daewoo, Doo- san
SY1232166	13.50" 343mm	0.75" 19mm	EZ-GO		SY1236711	13.78" 350mm	3.66" 93mm Clark
SY44839	13.50" 343mm	1.97" 50mm	Hyster, Yale, Clark		SY1236646	13.85" 352mm	0.75" 19mm Taylor Dunn
SY44176	13.50" 343mm	2.57" 65mm	Caterpillar, Toyota, Yale		SY1232185	13.86" 352mm	0.75" 19mm Taylor Dunn

 CA PROP 65 WARNING: Cancer/Reproductive Harm www.p65warnings.ca.gov

Steering Hand Wheels Columnas de Dirección Colonne Direction

	O.D. ▼	I.D.	Used for		O.D. ▼	I.D.	Used for	
SY1232143	13.98" 355mm	1.34" 34mm	TCM		SY1232141	14.09" 358mm	0.69" 18mm	Nissan
SY1239304	13.98" 355mm	1.38" 35mm	Toyota		SY1232136	14.17" 360mm	1.30" 33mm	Heli
SY1232134	13.98" 355mm	1.99" 51mm	Crown		SY1232162	14.25" 362mm	2.17" 55mm	SkyTrak, JLG, Gradall
SY35420	14.00" 356mm	1.97" 50mm	Yale, Hyster		SY1232139	15.75" 400mm	1.57" 40mm	JCB
SY1232144	14.06" 357mm	2.60" 66mm	TCM		SY1239300	16.00" 406mm		Taylor Dunn
SY1232147	14.06" 357mm	2.95" 75mm	Toyota		SY91845	17.00" 432mm	3.07" 78mm	Hyster, Toyota, Clark
SY1239302	14.06" 357mm	3.90" 99mm	Advance		SY45702	17.00" 432mm	3.07" 78mm	Hyster, Clark, Caterpillar, Allis Chalmers

 CA PROP 65 WARNING: Cancer/Reproductive Harm www.p65warnings.ca.gov

Steering Knobs Puños de Dirección Boutons de Direction

Steering Knob with Support



	Length ▼	Diameter	Used for
SY1239311	1.77" 45mm	2.05" 52mm	Caterpillar



	Length ▼	Diameter	Used for
SY1239310	2.80" 71mm	2.01" 51mm	Caterpillar



SY76938	2.09" 53mm	1.56" 40mm	Toyota
---------	---------------	---------------	--------



SY31513	2.91" 74mm	2.05" 52mm	Yale
---------	---------------	---------------	------



SY39554	2.15" 55mm	2.39" 61mm	Hyster
---------	---------------	---------------	--------



SY91719	2.95" 75mm	2.05" 52mm	Moffett
---------	---------------	---------------	---------



SY1232397	2.20" 56mm	2.20" 56mm	Hyster
-----------	---------------	---------------	--------



SY87719	3.06" 78mm	2.01" 51mm	TCM
---------	---------------	---------------	-----



SY87702	2.28" 58mm	2.32" 59mm	Crown
---------	---------------	---------------	-------



SY1232477	3.15" 80mm	1.97" 50mm	Teledyne
-----------	---------------	---------------	----------



SY91070	2.36" 60mm	2.09" 53mm	Raymond
---------	---------------	---------------	---------



SY76893	3.15" 80mm	2.01" 51mm	Toyota
---------	---------------	---------------	--------



SY87694	2.48" 63mm	2.20" 56mm	Clark
---------	---------------	---------------	-------



SY43469	3.19" 81mm	2.01" 51mm	Crown
---------	---------------	---------------	-------



⚠ CA PROP 65 WARNING: Cancer/Reproductive Harm www.p65warnings.ca.gov

Steering Knobs **Puños de Dirección** Boutons de Direction

	Length ▼	Diameter	Used for		Length ▼	Diameter	Used for		
SY1239313	3.19" 81mm	2.17" 55mm	Daewoo		SY340115	3.65" 93mm	2.05" 52mm	Toyota	
SY76907	3.23" 82mm	2.01" 51mm	Toyota		SY52130	3.82" 97mm	2.01" 51mm	Yale	
SY86973	3.31" 84mm	2.01" 51mm	Toyota		SY83135	3.98" 101mm	2.09" 53mm	Hyster, Yale	
SY1239312	3.35" 85mm	2.01" 51mm	Caterpillar		SY38232	4.02" 102mm	1.83" 46mm	Hyster	
SY1232398	3.35" 85mm	2.05" 52mm	Crown		SY340015	4.28" 109mm	2.05" 52mm	Toyota	
SY1232399	3.35" 85mm	2.05" 52mm	Hyundai		SY52194	4.41" 112mm	2.17" 55mm	Yale	
SY1239309	3.50" 89mm	2.05" 52mm	Clark		SY31699	4.57" 116mm	2.01" 51mm	Hyster	
SY52118	3.54" 90mm	1.85" 47mm	Yale						

 CA PROP 65 WARNING: Cancer/Reproductive Harm www.p65warnings.ca.gov

Steering Knobs **Puños de Dirección** Boutons de Direction

Control Knobs

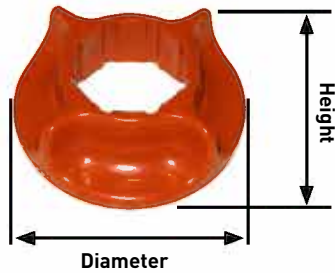

	Diameter ▼	Height	Material	Color
SY41612	1.81" 46mm	2.36" 60mm	Plastic	Black



SY41613	1.81" 46mm	2.36" 60mm	Plastic	Black
---------	---------------	---------------	---------	-------



	Diameter ▼	Height	Material	Color
SY1232288	2.97" 75mm	0.98" 25mm	Plastic	Red



SY34646	3.10" 79mm	2.25" 57mm	Plastic	Yellow
---------	---------------	---------------	---------	--------



SY1232286	2.97" 75mm	0.98" 25mm	Plastic	Orange
-----------	---------------	---------------	---------	--------



SY58541	3.58" 91mm	0.59" 15mm	Plastic	Yellow
---------	---------------	---------------	---------	--------



SY1232287	2.97" 75mm	0.98" 25mm	Plastic	Gray
-----------	---------------	---------------	---------	------



SY1236686	3.58" 91mm	0.59" 15mm	Plastic	Yellow
-----------	---------------	---------------	---------	--------



⚠ CA PROP 65 WARNING: Cancer/Reproductive Harm www.p65warnings.ca.gov

Steer Axles Ejes de Dirección Essieu Direction

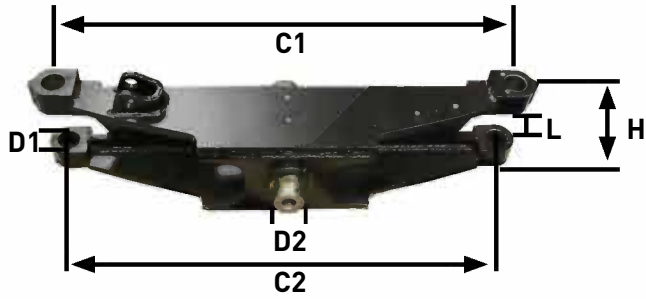

	Type	C1 ▼	D1	D2	L	H
SY1248881	U-Shape	28.62" 727mm	1.53" 39mm	1.96" 50mm	3.94" 100mm	7.28" 185mm
SY1248883	U-Shape	28.62" 727mm	1.53" 39mm	1.96" 50mm	3.94" 100mm	7.44" 189mm
SY1248885	U-Shape	28.62" 727mm	1.53" 39mm	1.96" 50mm	3.94" 100mm	7.44" 189mm
SY1248886	U-Shape	28.62" 727mm	1.53" 39mm	1.96" 50mm	3.94" 100mm	7.50" 191mm
SY1248884	U-Shape	31.31" 795mm	1.53" 39mm	1.96" 50mm	3.88" 99mm	7.56" 192mm
SY1248882	U-Shape	31.31" 795 mm	1.53" 39mm	1.96" 50mm	3.94" 100mm	7.40" 188mm
SY1248887	U-Shape	31.31" 795mm	1.53" 39mm	1.96" 50mm	3.94" 100mm	7.56" 192mm
SY1248888	U-Shape	35.81" 910mm	1.75" 44mm	2.56" 65mm	4.72" 120mm	8.56" 217mm

CA PROP 65 WARNING: Cancer/Reproductive Harm www.p65warnings.ca.gov

TY-V0: BASE TYPE

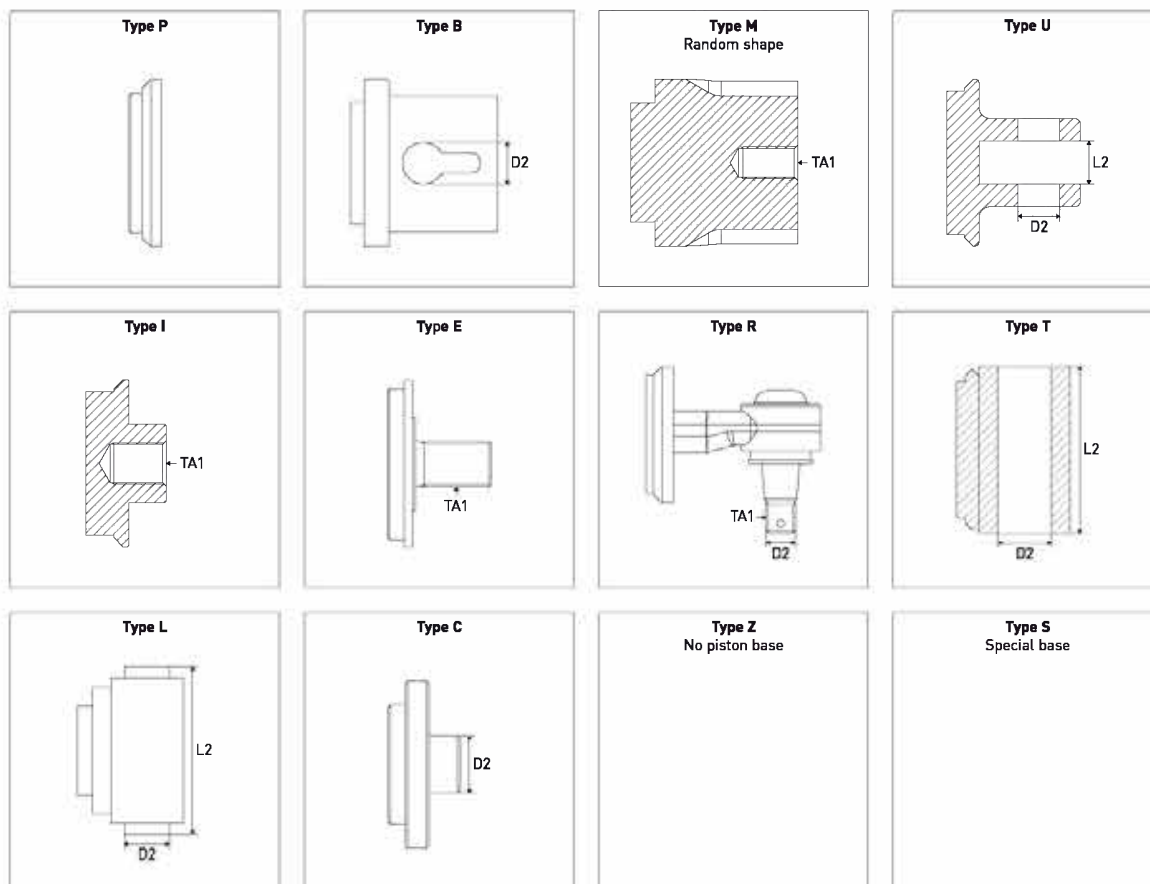

	Base Type	Total Cylinder Length, Fully Retracted ▼	Piston Shaft	Stroke
SY28-103100	No piston base	11.83" 300mm		
				
SY93139	M	18.45" 469mm		
				
SY93131	I	19.53" 496mm	17.79" 452mm	
				

 CA PROP 65 WARNING: Cancer/Reproductive Harm www.p65warnings.ca.gov

Steering Cylinders Cilindros de Dirección Cylindres de direction

	Base Type	Total Cylinder Length, Fully Retracted ▼	Piston Shaft	Stroke
SY93134	R	20.08" 510mm	16.65" 423mm	9.05" 230mm
				
SY57034	No piston base	20.43" 519mm		
				
SY33005	No piston base	20.47" 520mm		
				
SY52602	No piston base	20.47" 520mm		5.62" 143mm
				
SY93130	R	20.47" 520mm		
				
SY93138	R	21.26" 540mm		8.85" 225mm
				
SY35215	No piston base	21.85" 555mm		6.69" 170mm
				
SY87841	No piston base	22.05" 560mm		
				

 CA PROP 65 WARNING: Cancer/Reproductive Harm www.p65warnings.ca.gov

Steering Cylinders **Cilindros de Dirección** Cylindres de direction

	Base Type	Total Cylinder Length, Fully Retracted ▼	Piston Shaft	Stroke
SY108082	R	22.84" 580mm		10.70" 272mm
				
SY93132	No piston base	23.62" 600mm		
				
SY93135	No piston base	24.41" 620mm		7.48" 190mm
				
SY1248983	Special base	24.61" 625mm		
				
SY87022	Z	25.87" 657mm		
				
SY93137	No piston base	26.38" 670mm		22.44" 570mm
				
SY41026	R	26.38" 670mm		
				
SY93136	No piston base	27.95" 710mm		
				

 CA PROP 65 WARNING: Cancer/Reproductive Harm www.p65warnings.ca.gov

Remanufactured Steer Axles Ejes de Dirección Remanufacturados Essieu de Direction Réusiné

SY1258007 **Make ▼**
Caterpillar



SY1258008 **Make ▼**
Caterpillar



SY1258006 **Make ▼**
Clark



SY1258011 **Make ▼**
Crown



SY1258000 **Make ▼**
Hyster



SY1258001 **Make ▼**
Hyster



SY1258002 **Make ▼**
Hyster



SY1258003 **Make ▼**
Hyster



SY1258004 **Make ▼**
Hyster



SY1258005 **Make ▼**
Hyster



SY1258021 **Make ▼**
Komatsu



SY1258009 **Make ▼**
Mitsubishi



SY1258010 **Make ▼**
Mitsubishi



SY1258012 **Make ▼**
Toyota



 CA PROP 65 WARNING: Cancer/Reproductive Harm www.p65warnings.ca.gov

Remanufactured Steer Axles Ejes de Dirección Remanufacturados Essieu de Direction Réusiné

Make ▼

SY1258013

Toyota



Make ▼

SY1258018

Toyota



SY1258014

Toyota



SY1258019

Toyota



SY1258015

Toyota



SY1258020

Toyota



SY1258016

Toyota



SY54210

Yale



SY1258017

Toyota



 CA PROP 65 WARNING: Cancer/Reproductive Harm www.p65warnings.ca.gov